

Plastic shell外壳

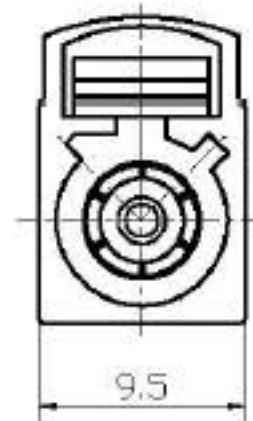

9.5

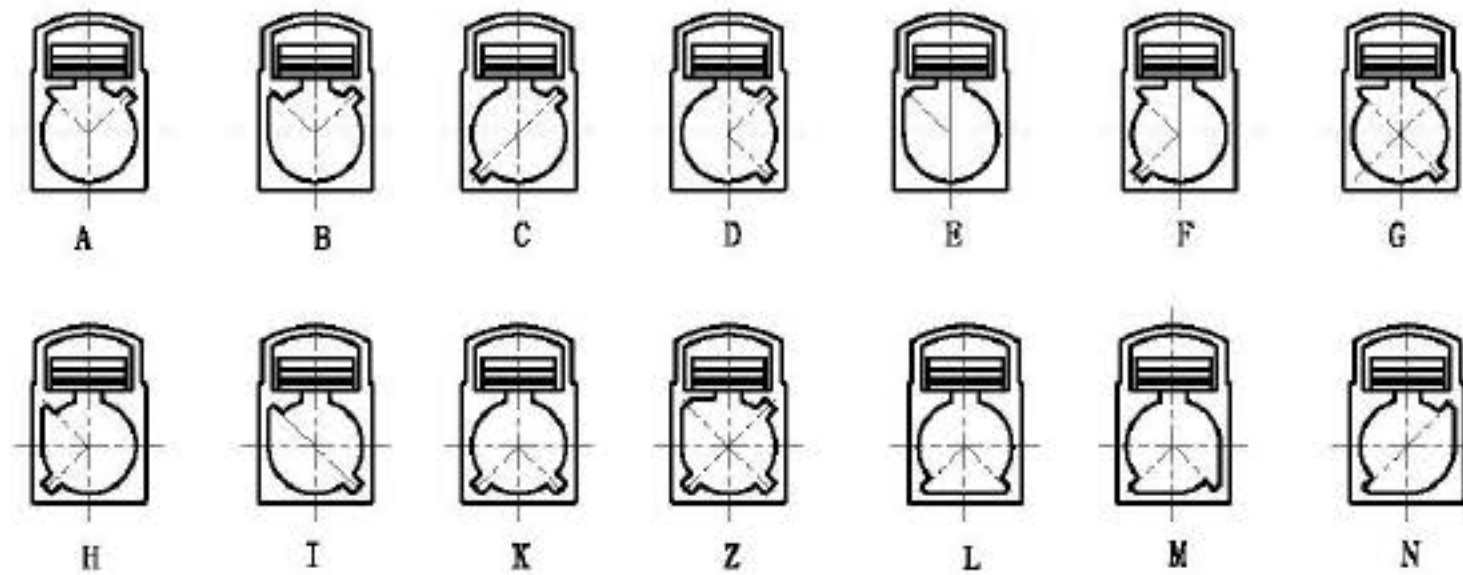

Port Type

Package:

1. Copper: 100pcs/PE bag;
2. Pin contact: 100pcs/PE bag;
3. Plastic shell 100pcs & above parts/PE bag;
4. Carton: Yellow Corrugated Carton.

包装:

1. 铜管: 100pcs/PE袋;
2. 中心针: 100pcs/PE袋;
3. 塑胶五金壳100pcs+以上配件/PE袋;
4. 外箱: 黄色瓦楞纸箱.

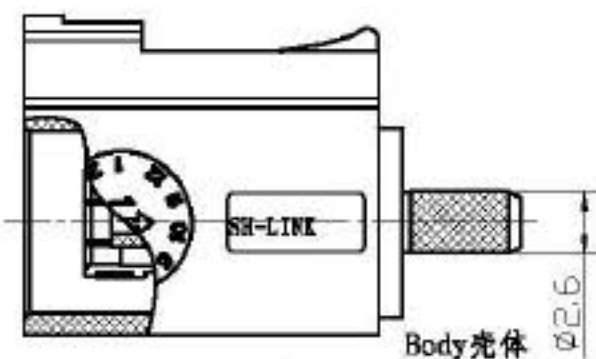

Plastic shell外壳

Body壳体

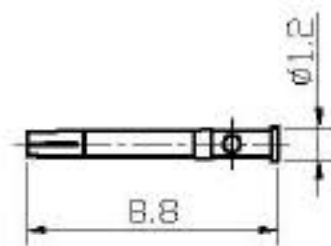

Pin contact中心针

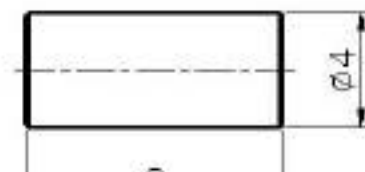

Copper tube铜管

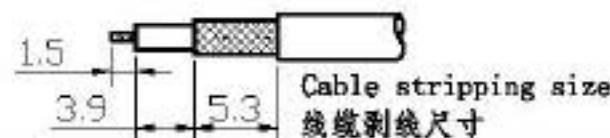

Cable stripping size
线缆剥线尺寸

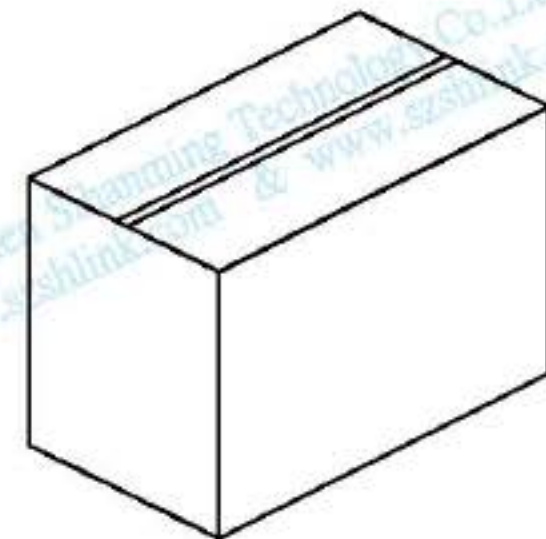
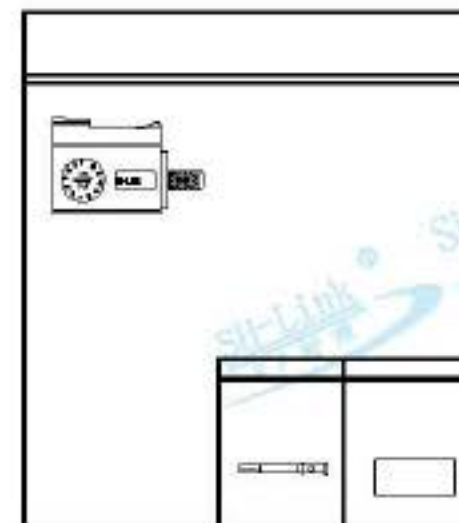

NO	DESCRIPTION描述	MATERIAL材质	SPECIFICATION规格	QTY数量	Limits	A(±)	B(±)	C(±)	D(±)	E(±)	F(±)	SIGNATURE	DATE作成日期	SH-Link® 深圳市思翰铭科技有限公司 RF射频 Shenzhen Sihanning Technology Co., Ltd						
7															SCALE 比例 2:1	WEIGHT 重量(g) 3.38	PERSPECTIVE 视角方法	ITEM NO品号	PART DESCRIPTION品名	
6	Plastic shell外壳	PA66+30%GF		1	0-6	0.03	0.05	0.08	0.10	0.15	0.20									
5	Snap ring卡圈	Beryllium copper铍铜		1	6-18	0.05	0.08	0.10	0.15	0.20	0.25									
4	Copper tube铜管	Brass黄铜	Nickel plated镀镍	1	18-30	0.08	0.10	0.15	0.20	0.25	0.35									
3	Insulator绝缘体	PIFE聚四氟乙烯		1	30-50	0.10	0.15	0.20	0.25	0.30	0.50									
2	Pin contact中心针	Beryllium copper铍铜	Gold plated镀金	1	50-80	0.15	0.20	0.25	0.35	0.50	0.65									
1	Body壳体	Brass黄铜	Nickel plated镀镍	1	80-120	0.20	0.25	0.30	0.50	0.65	0.80									
					120-180	0.25	0.35	0.50	0.65	0.80	0.95									
					180-250	0.35	0.50	0.65	0.95	0.95	1.15									
													APPROVED BY		SHM. 900. 0003-2		FAKRA SMB-C-K1.5-2			

RoHS Outline Drawing

SH-Link
Shenzhen Sihanning Technology Co., Ltd
www.szshlink.com & www.szshlink.cn

Type	Color	For Cable	Item No
A	BLACK (黑色)	RG174/316线	SHM. 900. 0003-2. A
B	WHITE (白色)		SHM. 900. 0003-2. B
C	BLUE (蓝色)		SHM. 900. 0003-2. C
D	BORDEAUX VIOLET (紫红色)		SHM. 900. 0003-2. D
E	GREEN (军绿色)		SHM. 900. 0003-2. E
F	BROWN (棕褐色)		SHM. 900. 0003-2. F
G	GREY (灰色)		SHM. 900. 0003-2. G
H	VIOLET (粉红色)		SHM. 900. 0003-2. H
I	BEIGE (米黄色)		SHM. 900. 0003-2. I
K	CURRY (土黄色)		SHM. 900. 0003-2. K
Z	WATER BLUE (水蓝色)		SHM. 900. 0003-2. Z
L	CARMINE RED (桔红色)		SHM. 900. 0003-2. L
M	PASTEL ORANGE (橙色)		SHM. 900. 0003-2. M
N	PASTEL GREEN (浅绿色)		SHM. 900. 0003-2. N

SH-Link
Shenzhen Sihanning Technology Co., Ltd
www.szshlink.com & www.szshlink.cn

NO	DESCRIPTION 描述	MATERIAL 材质	SPECIFICATION 规格	QTY 数量	Limits	SIGNATURE DATE 作成日期						SH-Link® 深圳市思翰铭科技有限公司 RF 射频 Shenzhen Sihanning Technology Co., Ltd					
						A(±)	B(±)	C(±)	D(±)	E(±)	F(±)	SCALE 比例	WEIGHT 重量(g)	PERSPECTIVE 视角方法	ITEM NO 品号	PART DESCRIPTION 品名	
					0-6	0.03	0.05	0.08	0.10	0.15	0.20	DRAWN BY	2:1	3.38	PERSPECTIVE 视角方法	ITEM NO 品号	PART DESCRIPTION 品名
					6-18	0.05	0.08	0.10	0.15	0.20	0.25						
					18-30	0.08	0.10	0.15	0.20	0.25	0.35	CHECKED BY	SHM. 900. 0003-2	FAKRA SMB-C-K1.5-2			
					30-50	0.10	0.15	0.20	0.25	0.30	0.50						
					50-80	0.15	0.20	0.25	0.35	0.50	0.65	APPROVED BY					
					80-120	0.20	0.25	0.30	0.50	0.65	0.80						
					120-180	0.25	0.35	0.50	0.65	0.80	0.95						
					180-250	0.35	0.50	0.65	0.95	0.95	1.15						